

CS 9300 Family

Safety, Regulatory and Technical Specification User Guide

Including

CS 9300

CS 9300C

CS 9300 Select

CS 9300C Select

Notice

The Regulatory Information and Technical Specifications User Guide for the CS 9300 Family includes information on the safety instructions, regulatory information and the technical specifications of the following devices: CS 9300, CS 9300 Select, CS 9300C and CS 9300C Select.

The CS 9300 Family includes:

- CS 9300: panoramic, dental volumetric reconstruction modality including ENT.
- CS 9300 Select: panoramic, dental volumetric reconstruction modality without ENT.
- CS 9300C: panoramic, dental volumetric reconstruction, cephalometric modality including ENT.
- CS 9300C Select: panoramic, dental volumetric reconstruction, cephalometric modality without ENT.

CS 9300 and CS 9300 Select can be upgraded to a cephalometric modality, when the Cephalostat module is provided as an upgrade kit.

In this guide the generic name CS 9300 Family is used when the information refer to all models. If not the specific name of each model is used.

We recommend that you thoroughly familiarize yourself with this Guide in order to make the most effective use of your system.

The information contained in this CS 9300 Family Guide may be subject to modification without notice, justification or notification to the persons concerned.

No part of this Guide may be reproduced without the express permission of Carestream Dental LLC.

U.S. Federal law restricts this device to sale by or on the order of a dentist or physician.

This document is originally written in English.

Manual Name: CS 9300 Family Safety, Regulatory and Technical Specifications User Guide
Part Number: SM747
Revision Number: 10
Print Date: 2019-04

The CS 9300 Family complies with Directive 93/42/EEC relating to medical devices:



Contents

1 Safety Information	- 4 -
Indications for Use	- 4 -
Conventions in this Guide	- 4 -
Note to the User	- 5 -
Warning and Safety Instructions	- 5 -
Cleaning and Disinfection	- 7 -
Cleaning the CS 9300 Family Units	- 7 -
Cleaning and Disinfecting the Accessories.....	- 8 -
Marking and Labeling Symbols	- 13 -
Label Locations	- 14 -
CS 9300 Family Labels.....	- 14 -
2 Regulatory Information	- 16 -
General Regulatory Information	- 16 -
Compliance with International Regulations.....	- 21 -
3 Technical Specifications	- 22 -
Factory	- 22 -
Manufacturer	- 22 -
Model	- 22 -
CS 9300 Family Technical Specifications	- 23 -
Minimum Computer System Requirement.....	- 26 -
X-ray Dose Emission Information.....	- 27 -
3D Mode for CS 9300 and CS 9300C.....	- 27 -
3D Mode for CS 9300 Select and CS 9300C Select	- 29 -
Panoramic Mode for CS 9300 Family	- 31 -
Cephalometric Mode for CS 9300 Family	- 32 -
User Dose information	- 34 -
Stray radiation	- 34 -
3D Mode for CS 9300 and CS 9300C.....	- 35 -
3D Mode for CS 9300 Select and CS 9300C Select	- 36 -
3D Mode Teeth for CS 9300 Family.....	- 37 -
Panoramic Mode for CS 9300 Family	- 38 -
Imaging Performance Information.....	- 38 -
Controlling the Image Quality	- 38 -
CS 9300 Family Environmental Requirements	- 39 -
CS 9300 Family Electrical Specifications.....	- 40 -
X-ray Tube Assembly Technical Specifications.....	- 42 -
4 Contact Information	- 53 -
Manufacturer's Address	- 53 -
Authorized Representatives	- 53 -

1 Safety Information

Indications for Use

The CS 9300 family is intended to produce two-dimensional and three-dimensional digital X-ray images of the dento-maxillofacial and ENT** (ear, nose and throat) areas to be used at the direction of healthcare professionals as diagnostic support for pediatric and adult patients. In addition, the CS 9300C and CS 9300C Select are systems that are also intended to produce cephalometric images. This includes imaging the hand and wrist to obtain the carpus image for growth and maturity assessment.

The CS 9300 family includes:

- ****CS 9300:** panoramic, dental volumetric reconstruction modality including ENT.
- ****CS 9300C:** panoramic, cephalometric, dental volumetric reconstruction modality including ENT.
- **CS 9300 Select:** panoramic, dental volumetric reconstruction modality without ENT.
- **CS 9300C Select:** panoramic, cephalometric, dental volumetric reconstruction modality without ENT.

CS 9300 and CS 9300 Select can be upgraded to a cephalometric modality, when the Cephalostat module is provided as an upgrade kit.



WARNING: Do not use cone beam imaging for routine or screening examinations. Consider using other diagnostic tools. You must justify that the imaging method that you use to examine each patient demonstrates that the benefit outweighs the risks.

Conventions in this Guide

The following special messages emphasize information or indicate potential risk to personnel or equipment:



WARNING: Warns you to avoid injury to yourself or others by following the safety instructions precisely.



CAUTION: Alerts you to a condition that might cause serious damage.



Important: Alerts you to a condition that light cause problems.



Note: Emphasizes important information.



Tip: Provides extra information and hints.

Note to the User



WARNING: X-rays can be harmful and dangerous if not used properly. The instructions and warnings contained in this guide must be followed carefully.

As a manufacturer of radiology units that conform to stringent radiological protection standards in force throughout the world, we guarantee as low as reasonably achievable degree of protection against radiation hazards. Nonetheless, you are handling a radiology unit specially designed to emit X-ray doses in order to carry out a medical diagnosis.

The room in which your radiology unit is to be installed must comply with all official regulations applicable to protection against radiation. You must install your radiology unit in a room protected against X-ray emission.

Your local representative will assist you in the initial use of your radiology unit and will supply any relevant information you may require.

To use and operate your unit and your digital imaging software you must follow the instructions contained in this guide.

Warning and Safety Instructions

When operating your unit, observe the following warning and safety instructions:

	<p>DANGER OF ELECTRIC SHOCK This is an electrical unit. Do NOT expose it to water spray. Such action may cause an electric shock or a malfunction of the unit.</p>
	<p>LASER WARNING For maximum safety, advise the patient not to look at the beam. Before turning on the beams, lower the Frankfort plane beam to the lowest level. While making adjustments, ensure that the beam is not directed into the eyes of the patient.</p> <p>CAUTION Use of controls, adjustments or performance of procedures other than those specified herein may result in hazardous radiation exposure.</p>



WARNINGS

Unit:

- Read and understand this Safety Information before using your unit
- You are responsible for the operation and maintenance of this unit. Only legally qualified persons can operate this unit. They **MUST** have training to use the radiological equipment. Do **NOT** open the cover of the unit. When necessary, have a trained authorized service technician carry out inspection and maintenance operations.
- Install this unit in an X-ray room that complies with current installation standards. From this location, you must be able to maintain visual or audio communication with the patient and be able to access the Acquisition interface module during exposure.
- This unit must be permanently connected to the ground with a fixed power supply cable. To avoid the risk of electric shock, this equipment must **ONLY** be connected to a mains supply with protective earth.
- Do **NOT** operate the unit if there is the threat of an earthquake. Following an earthquake, ensure that the unit is operating satisfactorily before using it again. Failure to observe this precaution may expose patients to hazards.
- X-ray equipment is hazardous to patients and the operator if you do not observe the exposure safety factors and operating instructions.
- Do **NOT** place objects within the field of operation of the unit.
- The patient should wear a protective lead-lined shoulder apron, unless other Radiation Protection Protocols apply locally.
- While adjusting the height of the unit, ensure that the patient is kept clear of the mechanism.
- When the unit is not in use, ensure that the ON/OFF switch is set to OFF (O).
- If the unit develops a fault, switch it to off (O), display an “Unserviceable” notice and contact a service technician.
- To dispose of the unit or its components, contact a service technician.
- Ask the patient to refrain from moving during the entire period of exposure.
- Ask the patient to remain still until the unit arm has stopped moving and the RESET movement has completed.
- Do **NOT** use this unit in conjunction with oxygen-rich environments. This unit is not intended for use with flammable anesthetics or flammable agents.
- Do **NOT** hang from the cephalostat.
- It is not recommended to use accessories other than those specified in this document and sold by Carestream Dental.

Computer:

- **Do NOT place the computer and the peripheral equipment connected to it in the immediate vicinity of the patient in the unit. Leave at least 1.83 m distance between the patient and the unit. The computer and the peripheral equipment must conform to the IEC60950 standard.**
- **See your computer installation guide for details of the data processing system and screen. Leave a sufficient amount of clear space around the CPU to ensure that it is properly ventilated.**
- **To obtain maximum image quality and visual comfort, position the screen to avoid direct light reflections from internal or external lighting.**
- **Always use Microsoft Windows Update to make sure that the latest security patches are correctly installed.**

Cleaning and Disinfection

Daily

Cleaning the CS 9300 Family Units

1. Switch off the unit.
2. Remove all visible soil, if any, with disposable cloth or paper wipe.



Note: No disassembly shall be performed on the unit

3. Dampen (not soak) a lint-free cloth with soap and running water.
4. Thoroughly clean manually all accessible parts of the unit, including the temporal head clamps, with the dampened lint-free cloth.
5. Dry the unit with hygienic disposable cloth.
6. Dampen (not soak) a lint-free cloth with a low-level disinfectant that is U.S. Environmental Protection Agency (EPA)-registered or low-level disinfectant that is recognized by your Local Authority (for example, quaternary ammonium compounds and some phenolics). An EPA-registered hospital disinfectant or any other low-level disinfectant must have clear label claims for intended use.
7. Wipe thoroughly on all accessible parts of the unit with the dampened lint-free cloth. You must follow the disinfectant's manufacturer instructions for use, especially with respect to contact time.
8. Allow to dry in the open air for a minimum of 5 minutes.
9. Visually inspect the unit for signs of deterioration. If any damage is noted, do not use the unit and contact a service technician.



CAUTION

Avoid applying any cleaning liquid to the inside parts of the unit.

Cleaning and Disinfecting the Accessories

Cleaning and disinfecting the accessories that have contact with the mucous membranes



CAUTION

You **MUST** cover the standard bite block and the bite block for edentulous patients with FDA-cleared or CE marking protective sheaths that are available from distributors to use them between each patient.

We recommend that you cover the TMJ nose rest and the 3D bite block with FDA-cleared or CE marking protective sheaths that are available from distributors to use them between each patient.

To ensure maximum hygienic safety for the patient, follow the following instructions carefully to prepare them for use.

The following accessories must first be cleaned and then steam-sterilized between each patient use:

- TMJx4 nose rest
- Panoramic standard bite block
- Bite block for edentulous patient
- 3D bite block



Note: It is recommended that the accessory be reprocessed as soon as reasonably practical following use.

Cleaning

To clean the accessories that have contact with the mucous membranes, follow these steps:

1. Remove and discard the protective sheath from the accessory.
2. Remove all visible soil by with disposable cloth or paper wipe.
3. Rinse at least 1 minute under running water to thoroughly clean the accessory from any excess soil.
4. Using a soft brush, apply medical enzyme detergent solutions (basically with a multi-enzymatic formula) to all surfaces of the accessory. Detergent manufacturer's directions must be strictly adhered to.
5. Rinse thoroughly under running water for at least 1 minute to remove detergent residue.
6. Dry the accessory with compressed air or hygiene disposable cloth.
7. Visually inspect the accessory for residual soil. If soil is visible, either repeat steps 2 to 5, or safely dispose of the accessory.

Disinfecting with Steam Autoclave

To steam autoclave the accessory, once cleaning is complete, follow these steps:



CAUTION

To disinfect with heat, you must use a medical autoclaving equipment cleared by the FDA in the USA or that is recognized by your Local Authority.

You must always follow the operating parameters recommended by the manufacturer of the autoclaving equipment.

Use FDA cleared or CE mark standard packaging material.

1. Wrap the cleaned accessory using a standard packaging material for autoclaving.
2. Steam autoclave at 132°C (270°F) for 4 minutes in the USA or depending on your local regulation you can steam autoclave at 134°C (273°F) for 18 minutes.
3. Visually inspect the accessory for signs of deterioration. If any damage is noted, do not use the accessory and contact your representative.
4. Once sterilized, the accessory can be used immediately or stored dry and dust-free in its sterilization wrapping under temperature specified in section “CS 9300 Family Environmental Requirements” of the present guide.

Cleaning and disinfecting the ear cones



CAUTION

Ear cones must be covered with a FDA-cleared or CE marking protective sheath which is available from distributors.

After use, remove and discard the protective sheath. You must clean and disinfect the ear cones between each patient use with an EPA-registered, or CE marking, intermediate-level hospital disinfectant with label claims of tuberculocidal activity (for example: a chlorine containing product, a quaternary ammonium compound with alcohol, a phenolics, an iodophors, an EPA-registered chlorine-base product).

Cleaning

To clean the ear cones, follow these steps:

1. Remove and discard the protective sheath from the accessory.
2. Remove all visible soil by with disposable cloth or paper wipe.
3. Rinse at least 1 minute under running water to thoroughly clean the accessory from any excess soil.
4. Using a soft brush, apply medical enzyme detergent solutions (basically with a multi-enzymatic formula) to all surfaces of the accessory. Detergent manufacturer’s directions must be strictly adhered to.
5. Rinse thoroughly under running water for at least 1 minute to remove detergent residue.
6. Dry the accessory with compressed air or hygiene disposable cloth.

7. Visually inspect the accessory for residual soil. If soil is visible, either repeat steps 2 to 5, or safely dispose of the accessory.

Disinfecting

1. Use an intermediate-level disinfectant with tuberculocidal activity as identified above and as recommended by the manufacturer of the disinfectant.



WARNING

Do not rinse the ear cones.

2. Allow to dry in open air.

Cleaning and disinfecting the components and accessories that have skin contact

The following components and accessories must first be cleaned and then disinfected with a low-level disinfectant between each patient use:

- Panoramic/ TMJx2/ Sinus chin rest
- 3D bite block support
- 3D head rest
- Nasion support



Note: It is recommended that the accessory be reprocessed as soon as reasonably practical following use.

Cleaning

To manually clean the component or accessory that have skin contact, follow these steps:

1. Remove all visible soil by with disposable cloth or paper wipe.
2. Rinse at least 1 minute under running water to thoroughly clean the component/accessory from any excess soil.
3. Using a soft brush, apply medical enzyme detergent solutions (basically with a multi-enzymatic formula) to all surfaces of the component/accessory. Detergent manufacturer's directions must be strictly adhered to.
4. Rinse thoroughly under running water for at least 1 minute to remove detergent residue.
5. Dry the component/accessory with compressed air or hygiene disposable cloth.
6. Visually inspect the component/accessory for residual soil. If soil is visible, either repeat steps 1 to 4, or safely dispose of the accessory.

Disinfecting

To disinfect the component or accessory, once the cleaning is complete, follow these steps:

1. Disinfect the accessory by using an EPA-registered hospital disinfectant for low-level activity or low-level disinfectant that is recognized by your Local Authority (for example, quaternary ammonium compounds and some phenolics). You must follow the disinfectant's manufacturer instructions for use, especially with respect to contact time.



CAUTION

If there is a visible contamination with blood, you must clean the accessory with an EPA-registered hospital disinfectant for intermediate-level disinfectant or intermediate-level disinfectant that is recognized by your Local Authority that has claim for activity against hepatitis B after cleaning. The disinfectant's manufacturer instructions for use must always be followed, especially with respect to contact time.

Marking and Labeling Symbols



Type B device symbol complying with the IEC 60601-1 standard



In the European Union, this symbol indicates: Do NOT discard this product in a trash receptacle; use an appropriate recovery and recycling facility. Contact your local sales representative for additional information on the collection and recovery programs available for this product



Attention, consult accompanying document and Ionizing Radiation symbols warn you about radiation dangers.



LASER WARNING

Laser radiation. DO NOT stare into the beam.

Class 2 laser product.

Maximum output power: 1 mW, 650 nm, IEC 60825-1 Ed.2 (2007)

This unit emits laser radiation.



The ON/OFF button



Refer to instruction manual/booklet



Non-ionizing radiation



Manufactured Date



Manufacturer's address

Label Locations

CS 9300 Family Labels

The following figure illustrates the label locations.

Figure 1 CS 9300 and CS 9300 Select Label Locations

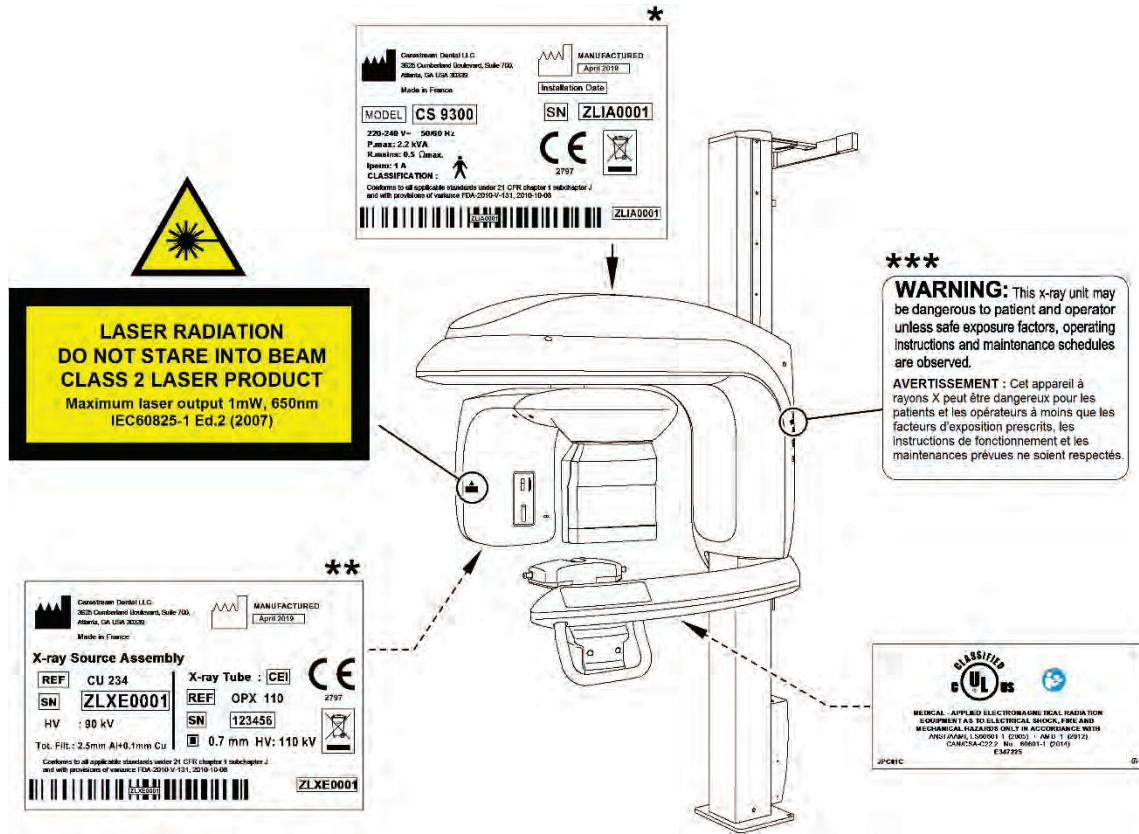

* or CS 9300 Select

** X-ray tube can be Toshiba or Canon D-067

*** **Important:** Only for USA this warning appears in the **Parameter** pane of the **Acquisition** interface.

The X-ray warning label also appears in the **Acquisition** interface.

Table 1 Label Definition

Label	Definition
	Defines the unit's model
	Defines the date that the unit was installed
	Defines the unit's compliance with the US CFR chapter 1 subchapter J and with provisions of FDA radiation standards variance FDA-2012-V0922, 2012-09-04

The following figure illustrates the label locations.

Figure 2 CS 9300C and CS 9300C Select Label Locations

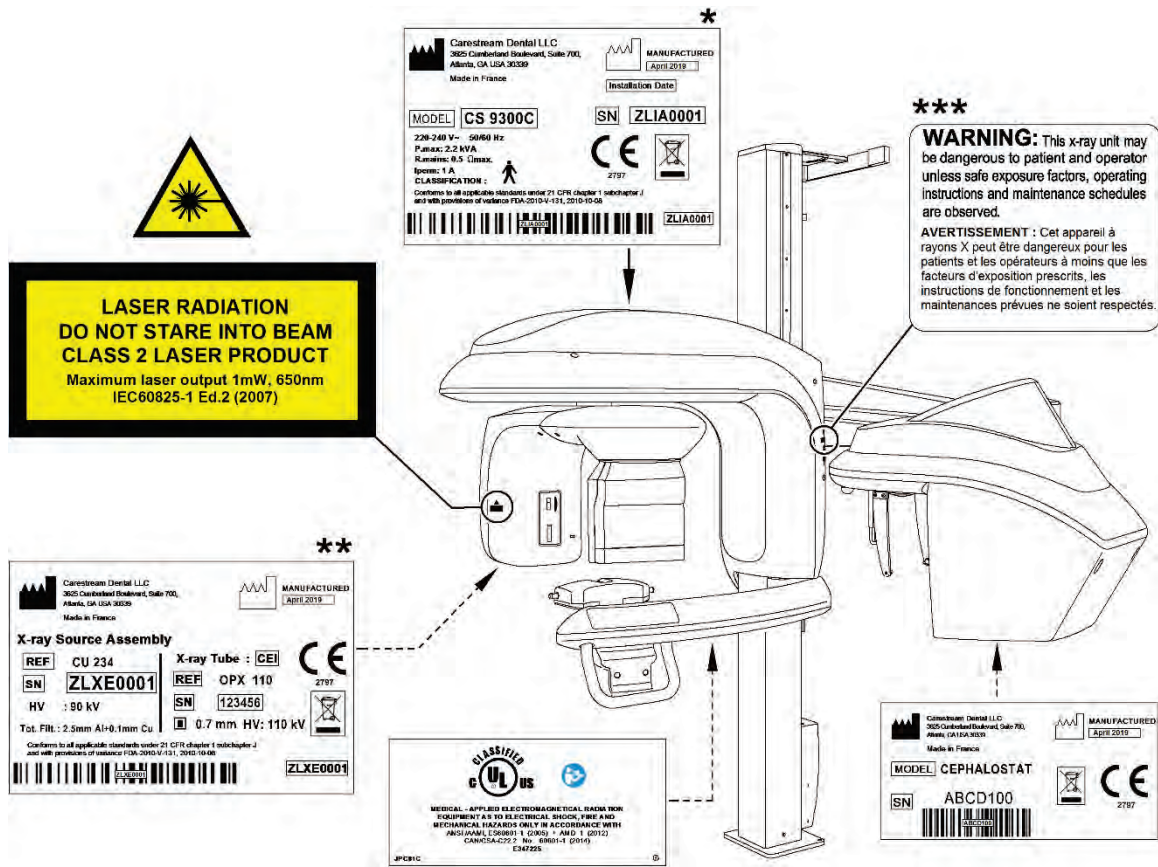

* or CS 9300C Select

** X-ray tube can be Toshiba or Canon D-067

*** **Important:** Only for USA this warning appears in the **Parameter** pane of the **Acquisition** interface.

The X-ray warning label also appears in the **Acquisition** interface.

Table 2 Label Definition

Label	Definition
	Defines the unit's model
	Defines the date that the unit was installed
Conforms to all applicable standards under 21 CFR chapter 1 subchapter J and with provisions of FDA radiation standards variance FDA-2012-V0922, 2012-09-04	Defines the unit's compliance with the US

2 Regulatory Information

General Regulatory Information

Compliance with European and International Standards

EN/IEC 60601-1	Medical Electrical Equipment - Part 1: General Requirements for basic Safety and essential performance.
EN/IEC 60601-1-2	Medical Electrical Equipment, Part 1-2: General requirements for basic Safety and essential performance - Collateral Standard: Electromagnetic Disturbances – Requirements and tests.
EN/IEC 60601-1-3	Medical Electrical Equipment, Part 1-3: General requirements for basic Safety and essential performance - Collateral Standard: Radiation protection in diagnostic X-ray equipment
EN/IEC 60601-1-6	Medical Electrical Equipment, Part 1-6: General requirements for basic Safety and essential performance - Collateral Standard: Usability
EN/IEC 62366	Medical devices - Application of usability engineering to medical device
EN/IEC 60601-2-63	Medical Electrical Equipment - Part 2-63: Particular requirements for the basic safety and essential performance of dental extra-oral X-ray equipment
EN/IEC 60825-1	Safety of laser products - Part 1: Equipment classification and requirements
EN/IEC 62304	Medical device software - Software life cycle processes.
EN ISO 15223-1	Medical devices - Symbols to be used with medical device labels, labeling and information to be supplied - Part 1: General requirements.
EN 1041	Information supplied by the manufacturer of medical devices.
ISO 10993-1	Biological evaluation of medical devices - Part 1: Evaluation and testing
ISO 14971	Medical devices - Application of risk management to medical devices
CAN/CSA C22.2 N° 60601-1	Medical Electrical Equipment - Part 1: General Requirements For Safety and essential performance.
ANSI/AAMI ES60601-1	Medical Electrical Equipment - Part 1: General Requirements For Safety and essential performance.

Classification in Accordance with EN/IEC 60601-1

Type of protection against electric shock Class 1 equipment

Degree of protection against electric shock Type B

Protection against harmful ingress of water Ordinary equipment

Operation mode Continuous operation with intermittent loading

Flammable anesthetics Not suitable for use in presence of flammable anesthetics or a mixture of flammable anesthetics with air or oxygen or nitrous oxide

Conformity with EN/IEC 60601-1-2

Group I, class B

CS 9300 is intended to be used in a professional healthcare facility environment.

Compliance of the CS 9300 family has been achieved using the following cables:

- One main supply cable (maximum length 3 m)
- Two Ethernet cables (maximum length 10 m)
- One X-ray switch cable (maximum length 10 m)

Conformity with EN/IEC 60601-1-2

Electromagnetic Compatibility Precautions



- Medical electrical equipment requires special precautions regarding electromagnetic compatibility (EMC).
- The CS 9300 family must be installed and put into service according to the EMC information provided in this document.
- The CS 9300 family may interfere with other equipment even if that other equipment complies with CISPR emission requirements.
- Portable and Mobile RF communications equipment can affect medical electrical equipment.

CS 9300 Components

CS 9300

CS 9300C Components

CS 9300C

CS 9300 Select Components

CS 9300 Select

CS 9300C Select Components

CS 9300C Select



- **Use limitation: the use of accessories, cables, or transducers other than those specified in the user's guide with the exception of cables, accessories or transducers sold by Carestream Dental LLC as replacement parts of internal components may result in increased emissions or decreased immunity of the CS 9300 family systems.**
- **The CS 9300 family systems should not be used adjacent to or stacked with other equipment. If adjacent or stacked use is necessary, the CS 9300 family systems should be observed to verify normal operation in the configuration in which it will be used.**



WARNING: The room in which your radiology unit is to be installed must comply with all official regulations applicable to protection against radiation. you must install your radiology unit in a room protected against X-ray emission.

Guidance and Manufacturer's Declaration - Electromagnetic Emissions (IEC 60601-1-2)

The CS 9300 family systems are intended for use in the electromagnetic environment specified below. The customer or the user of the CS 9300 family system should assure that it is used in such an environment.

Emissions Test	Compliance	Electromagnetic Environment - Guidance
RF emissions CISPR 11	Group 1	The CS 9300 family systems use RF energy only for their internal function. Therefore, their RF emissions are very low and are not likely to cause any interference in nearby electronic equipment.
RF emissions CISPR 11	Class B	The CS 9300 family systems are suitable for use in all establishments, including domestic establishments and those directly connected to the public low-voltage power supply network that supplies buildings used for domestic purposes.
Harmonic emissions IEC 61000-3-2	Class A	
Voltage fluctuations/ flicker emissions IEC 61000-3-3	Complies	

Guidance and Manufacturer's Declaration - Electromagnetic Immunity

The CS 9300 family systems are intended for use in the electromagnetic environment specified below. The customer or the user of the CS 9300 family system should assure that it is used in such an environment.

The essential performance concerns accuracy of loading factors (mA, kV), if the ESSENTIAL PERFORMANCE is lost or degraded due to EM DISTURBANCES, the system stops the examination and the user is notified of the error.

Immunity Test	IEC 60601 Test Level	Electromagnetic Environment - Guidance
Electrostatic discharge (ESD) IEC 61000-4-2	±8 kV contact ±15 kV air	Floors should be wood, concrete or ceramic tile. If floors are covered with synthetic material, the relative humidity should be at least 30 %.
Electrical fast transient/burst IEC 61000-4-4	±2 kV for power supply lines ±1 kV for input/output lines	Mains power quality should be that of a typical commercial or hospital environment.
Surge IEC 61000-4-5	±1 kV line(s) to line(s) ±2 kV line(s) to earth	Mains power quality should be that of a typical commercial or hospital environment.
Voltage dips, short interruptions and voltage variations on power supply input lines IEC 61000-4-11	0 % UT for 0.5 cycle at 8 angles At 0°, 0 % UT for 1 cycle and 70 % UT for 25 cycles	Mains power quality should be that of a typical commercial or hospital environment. If the user of the CS 9300 family system requires continued operation during power mains interruptions, it is recommended that the CS 9300 family systems be powered from an uninterruptible power supply or a battery.
Power frequency (50/60 Hz) magnetic field IEC 61000-4-8	30 A/m	Power frequency magnetic fields should be at levels characteristic of a typical location in a typical commercial or hospital environment

NOTE: UT is the a.c. mains voltage prior to application of the test level.

Guidance and Manufacturer's Declaration - Electromagnetic Immunity (IEC 60601-1-2)

The CS 9300 family systems are intended for use in the electromagnetic environment specified below. The customer or the user of the CS 9300 family systems should assure that it is used in such an environment.

Immunity Test	IEC 60601 Test Level	Electromagnetic Environment - Guidance
Conducted RF IEC 61000-4-6	3 Vrms 150 kHz to 80 MHz and 6V at ISM Frequencies and amateur radio frequencies	Environment of a care facility professional health.
Radiated RF IEC 61000-4-3	3 V/m 80 MHz to 2.7 GHz Test levels and frequencies according to table 9 from IEC 60601-1-2: 2014	WARNING: Portable RF communications equipment (including peripherals such as antenna cables and external antennas) should be used no closer than 30 cm (12 inches) to any part of the CS 9300 including cables specified by the manufacturer. Otherwise, degradation of the performance of this equipment could result

NOTE: These guidelines may not apply in all situations. Electromagnetic propagation is affected by absorption and reflection from structures, objects and people.

a. Field strengths from fixed transmitters, such as base stations for radio (cellular/cordless) telephones and land mobile radios, amateur radio, AM and FM radio broadcast and TV broadcast cannot be predicted theoretically with accuracy. To assess the electromagnetic environment due to fixed RF transmitters, an electromagnetic site survey should be considered. If the measured field strength in the location in which the CS 9300 family systems are used exceeds the applicable RF compliance level above, the CS 9300 family systems should be observed to verify normal operation. If abnormal performance is observed, additional measures may be necessary, such as re-orienting or relocating the CS 9300 family.

Compliance with International Regulations

- Medical Device Directives 93/42/ European Economic Community (EEC), Class II b.
- Directive 2011/65/EU on the Restriction of the use of certain Hazardous Substances in electrical and electronic equipment (RoHS).
- FDA Center for Devices & Radiological Health 21 CFR chapter 1 subchapter J and with provisions of variance FDA-2012-V0922, 2012-09-04.
- NEMA XR 29-2013 Standard Attributes on CT Equipment Related to Dose Optimization and Management.
- Radiation Emitting Devices Act - C34 (Canada).
- Medical Devices Regulations (Canada).

3 Technical Specifications

Factory

TROPHY

4, rue F. Pelloutier, Croissy-Beaubourg

77435 Marne la Vallée Cedex 2, France

Manufacturer



Carestream Dental LLC

3625 Cumberland Boulevard, Suite 700,
Atlanta, GA USA 30339

Model

CS 9300

CS 9300C

CS 9300 Select

CS 9300C Select

CS 9300 Family Technical Specifications

The generic name CS 9300 Family is used when the information refer to all models. If not the specific name of each model is used

Table 3 CS 9300 Family Technical Specifications

Components	X-ray Generator
Tube voltage	60 - 90 kV
Tube current	2 - 15 mA
Frequency	140 kHz
Tube focal spot (IEC 60336)	0.7 mm with X-ray tube OPX 110 0.6 mm with X-ray tube D-067
Total filtration	> 2.5 mm eq. Al+ 0.1 mm Cu

Panoramic Modality	CS 9300 CS 9300C	CS 9300 Select CS 9300C Select
Sensor technology	TFT	
Sensor matrix	64 x 1536 pixels	64 x 1152 pixels
Image field	5 x 149 mm max (Adult) 5 x 119 mm max (Pediatric)	5 x 146.3 mm max (Adult) 5 x 119 mm max (Pediatric)
Gray scale	16384 - 14 bits	65536 - 16 bits
Magnification	1.22 ($\pm 10\%$)	
Exposure time	4 - 16 s Depending on the patient's type and the program selection	
Program	12 anatomical settings	
Radiological exams options	Panoramic, Segmented panoramic, Maxillary sinus, LA TMJ x 2, LA TMJ x 4	

Panoramic modality is not available in Australia when the device is installed only with the 3D modality.

3D Modality	CS 9300 CS 9300C	CS 9300 Select CS 9300C Select
Technology	Digital Volumetric Tomography (DVT)	
Sensor technology	TFT	
Scan mode	Continuous and pulse	
Scan time	12 – 20 seconds (+- 10%)	
Gray scale	16384 - 14 bits	65536 – 16 Bits
Volume size Max diameter x height in cm	5 x 5 8 x 8 10 x 5 10 x 10 17 x 6 17 x 11 17 x 13.5	5 x 5 8 x 8 10 x 5 10 x 10
Voxel size	90 - 500 µm	90 - 300 µm
Reconstruction time	Less than 2 minutes based on the recommended computer system configuration requirements	

Cephalometric Modality	CS 9300 CS 9300 Select	CS 9300C CS 9300C Select
Sensor technology	N/A	CCD
Sensor matrix	N/A	2100 x 2092 pixels
Image field	N/A	300 x 300 mm
Gray scale	N/A	16.384 - 14 bits
Magnification	N/A	1.15
Exposure time	N/A	0.1–3.2 s
Program	N/A	12 anatomical settings
Radiological exams options	N/A	<ul style="list-style-type: none"> ▪ Lateral ▪ Frontal AP or PA ▪ Oblique ▪ Submento-vertex ▪ Carpus

Cephalometric modality is not available in Australia when the device is installed only with the 3D modality.

Components	CS 9300 CS 9300 Select	CS 9300C CS 9300C Select
Input voltage (AC)	220-240 V – 50/60 Hz 100-130 V – 50/60 Hz	
Unit dimensions	1158 (L) x 1595 (D) x 2378 mm (H)* *Unit with 2225 mm (H) shorter column is also possible	2137 (L) x 1595 (D) x 2378 mm (H)* *Unit with 2225 mm (H) shorter column is also possible
Required space	1500 (L) x 2000 (D) x 2400 (H) mm	2230 (L) x 2000 (D) x 2400 (H) mm
Weight	160 kg (352 lb 12 oz)	N/A
Weight of only the cephalostat component	N/A	39 kg (86 lb)
Total weight	N/A	199 kg (438 lb 12 oz)

Minimum Computer System Requirement

The computer and the peripheral equipment must conform to the IEC 60950 standard.

Item	Viewing	Acquisition
CPU	2.4 GHz Intel Duo Core	2.4 GHz Intel Duo Core
RAM	4 GB	4 GB
Hard disk drive	<ul style="list-style-type: none"> ▪ 1.2 GB for software installation ▪ 250 GB free space to use the software 	<ul style="list-style-type: none"> ▪ 4 GB for software installation ▪ 500 GB free space to use the software
Graphic board	Nvidia/ATI based board supporting Open GL 1.2 with 512 MB of video RAM on AGP x8 video bus	<ul style="list-style-type: none"> ▪ Cuda version 6.5 or higher ▪ Compute capability 1.1 or higher ▪ Nvidia based board on PCI Express video bus with minimum 1GB of video RAM
Display	1024 x 768 minimum screen resolution 32 bits color mode	1280 x 1024 minimum screen resolution
Operating system*	<ul style="list-style-type: none"> ▪ Windows 7 (32 & 64 bits) ▪ Windows 8* (64 bits), Windows 8.1* (64 bits) ▪ Windows 10 (64 bits) 	<ul style="list-style-type: none"> ▪ Windows 7 (64 bits) ▪ Windows 8* (64 bits), Windows 8.1* (64 bits) ▪ Windows 10 (64 bits)
Ethernet interface	N/A	2 Ethernet interfaces: <ul style="list-style-type: none"> ▪ 100 Mbits system link connection ▪ 1 Intel Pro 1000 GT Ethernet sensor link connection
CD/DVD drive	A DVD-BURNER drive is required.	A DVD-BURNER drive is required.
Backup Media	Removable/portable, external hard disk drive	Removable/portable, external hard disk drive.
Mouse	A mouse with 2 buttons and a scroll wheel is required	A mouse with 2 buttons is required



Note: Always use Microsoft Windows Update to make sure that the latest security patches are correctly installed.

* not designed to support touch screen usage.

X-ray Dose Emission Information

The following information relating to the effective X-ray dose received by the patient was measured under the following conditions:

- The calculated dose is accurate to $\pm 30\%$.
- The radiation emission dose is expressed in $\text{mGy}\cdot\text{cm}^2$.
- Dose Area Product (DAP)/mAs ($\text{mGy}\cdot\text{cm}^2/\text{mAs}$) is a function of kV.

3D Mode for CS 9300 and CS 9300C

Table 4 Patient X-ray Dose information in 3D Mode for CS 9300 and CS 9300C

Program Pane	Examination Type	Size	See Figure 3
Head	Low dose	17x11 cm	A
Head	Fast	17x11 cm	A
Head	High quality	17x13.5 cm	A
Sinus	Fast	17x11 cm	A
Sinus	High quality	17x11 cm	A
Sinus	High quality	17x13.5 cm	A
Ears right or left	Fast	5x5 cm	F
Ears right or left	High quality	5x5 cm	F
Ears right or left	High quality	8x8 cm	D
Ears right and left	High quality	17x6 cm	C
TMJ right or left	Low dose	8x8 cm	D
TMJ right or left	High quality	8x8 cm	D
TMJ right and left	Low dose	17x6 cm	C
TMJ right and left	High quality	17x6 cm	C
Full Jaw	Low dose	8x8 cm	D
Full Jaw	High quality	8x8 cm	D
Full Jaw	Low dose	10x5 cm	E
Full Jaw	High quality	10x5 cm	E
Full Jaw	Low dose	10x10 cm	B
Full Jaw	High quality	10x10 cm	B
Teeth	Low dose	5x5 cm	F
Teeth	Fast	5x5 cm	F
Teeth	High quality	5x5 cm	F

Figure 3 3D Mode for CS 9300 and CS 9300C

$$\text{DAP} = F(\text{kV})$$

CS 9300 & CS 9300C

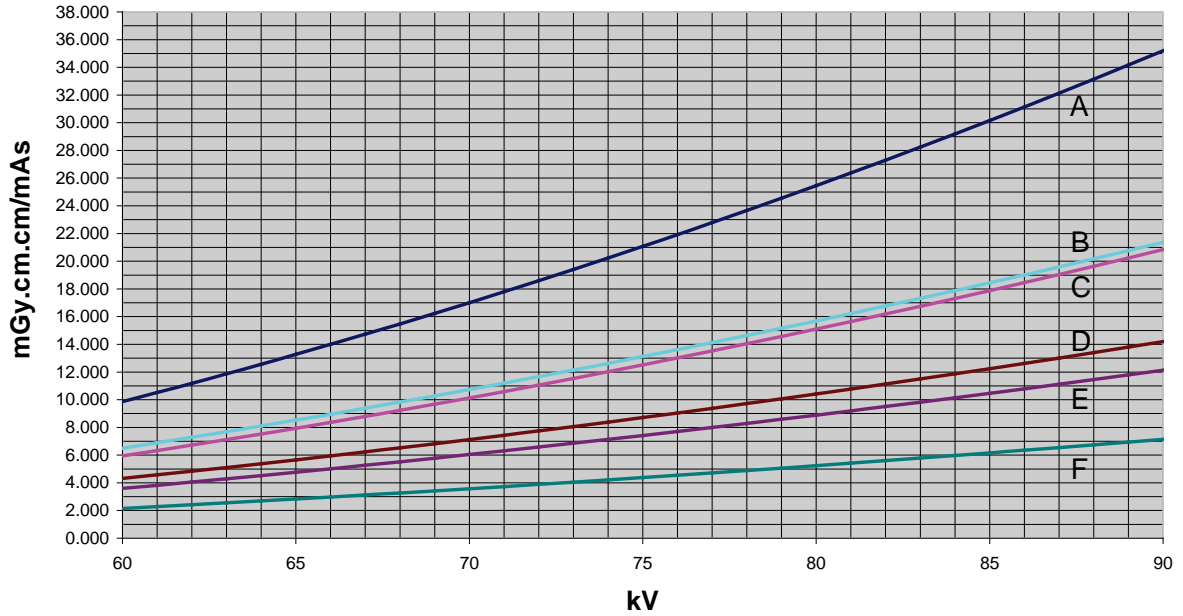

Example of a patient dose estimation in Jaw mode, 8 x 8 cm.

Radiological setting: 90 kV x 4 mA x 8 s

mAs = 4 mA x 8 s = 32 mAs

at 90 kV DAP = 14.2 mGy.cm²/mAs (see Curve D: Figure 3)

Patient dose estimation = 32 mAs x 14.2 mGy.cm²/mAs = 454 mGy.cm²

Pre-shoot mode, when activated, represents an increase in dose of maximum 0.5 % to the total dose of the selected 3D program.

3D Mode for CS 9300 Select and CS 9300C Select

Table 5 Patient X-ray Dose information in 3D Mode of CS 9300 Select and CS 9300C Select

Program Pane	Examination Type	Size	See Figure 4
Full Jaw	Low dose	8x8 cm	D
Full Jaw	High quality	8x8 cm	D
Full Jaw	Low dose	10x5 cm	E
Full Jaw	High quality	10x5 cm	E
Full Jaw	Low dose	10x10 cm	C
Full Jaw	High quality	10x10 cm	C
TMJ right or left	Low dose	8x8 cm	D
TMJ right or left	High quality	8x8 cm	D
Teeth	Low dose	5x5 cm	F
Teeth	Fast	5x5 cm	F
Teeth	High quality	5x5 cm	F

Figure 4

3D Mode for CS 9300 Select and CS 9300C Select

DAP = F (kV)
CS 9300 Select & CS 9300C Select

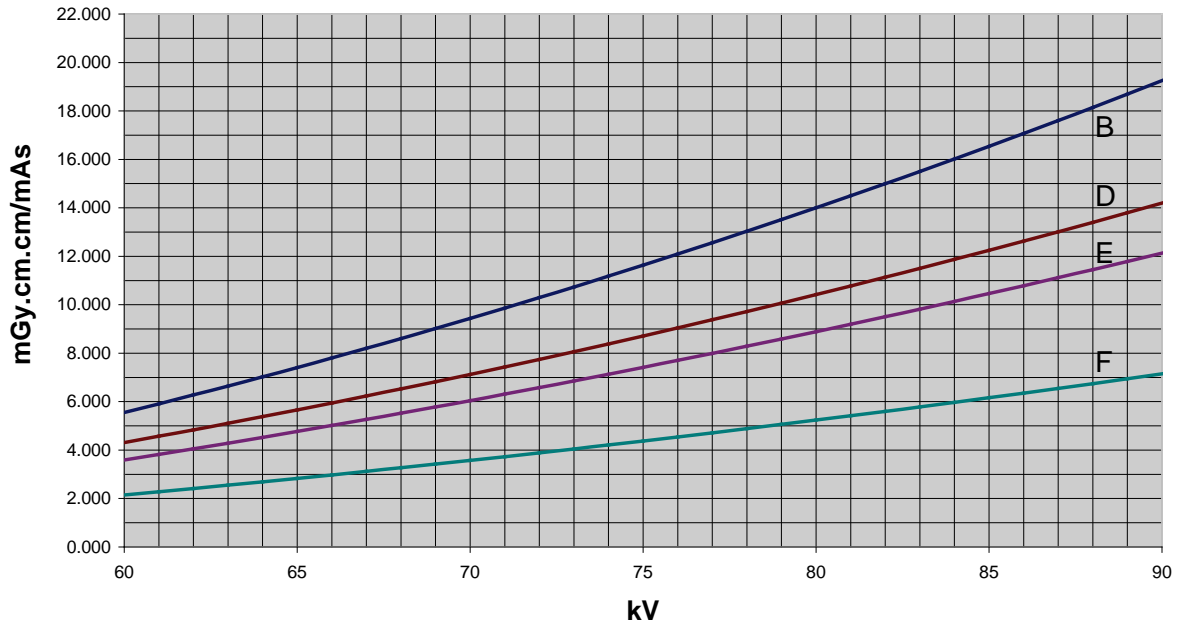

Example of a patient dose estimation in Jaw mode, 8 x 8 cm.

Radiological setting: 90 kV x 4 mA x 8 s

mAs = 4 mA x 8 s = 32 mAs

at 90 kV DAP = 14.2 mGy.cm²/mAs (see Curve D: Figure 4)

Patient dose estimation = 32 mAs x 14.2 mGy.cm²/mAs = 454 mGy.cm²

Pre-shoot mode, when activated, represents an increase in dose of maximum 0.5 % to the total dose of the selected 3D program.

Panoramic Mode for CS 9300 Family

Table 6 Patient Dose information in Panoramic Mode for CS 9300 Family

Program Pane	Examination Type	See Figure 5
Adult	Small	H
Adult	Medium	G
Adult	Large	G
Child	N/A	H

Figure 5 Panoramic Mode

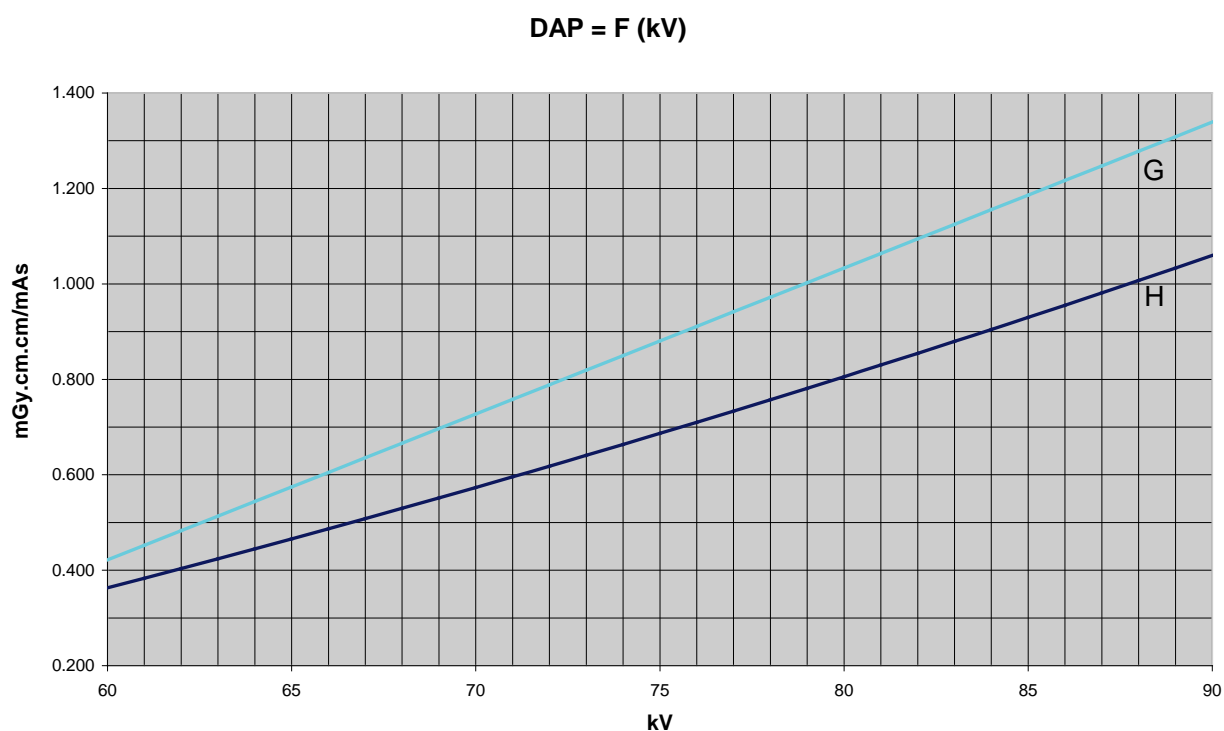

Example of a patient dose estimation in Large Adult panoramic mode.

Radiological setting: 74 kV x 10 mA x 16 s

mAs = 10 mA x 16 s = 160 mAs

at 74 kV DAP = 0.85 mGy.cm²/mAs (see Curve G: Figure 5)

Patient dose estimation = 160 mAs x 0.85 mGy.cm²/mAs = 136 mGy.cm²

Cephalometric Mode for CS 9300 Family

Table 7 Patient Dose information in Cephalometric Mode for CS 9300 Family

Cephalometric Exam	Acquisition Format Size (mm)	See Figure 6
Lateral	205x205	E
Lateral	205x274	D
Lateral	274x274	C
Lateral	274x300	B
Lateral	300x300	A
Cephalometric Exam	Acquisition Format Size (mm)	See Figure 7
Frontal AP or PA	205x205	J
Frontal AP or PA	205x274	I
Frontal AP or PA	274x274	H
Frontal AP or PA	274x300	G
Frontal AP or PA	300x300	F
Oblique	205x205	J
Oblique	205x274	I
Oblique	274x274	H
Oblique	274x300	G
Oblique	300x300	F
Submento-Vertex	205x205	J
Submento-Vertex	205x274	I
Submento-Vertex	274x274	H
Submento-Vertex	274x300	G
Submento-Vertex	300x300	F
Carpus	205x205	J
Carpus	205x274	I
Carpus	274x274	H
Carpus	274x300	G
Carpus	300x300	F

Figure 6 Cephalometric Mode (Lateral exam)

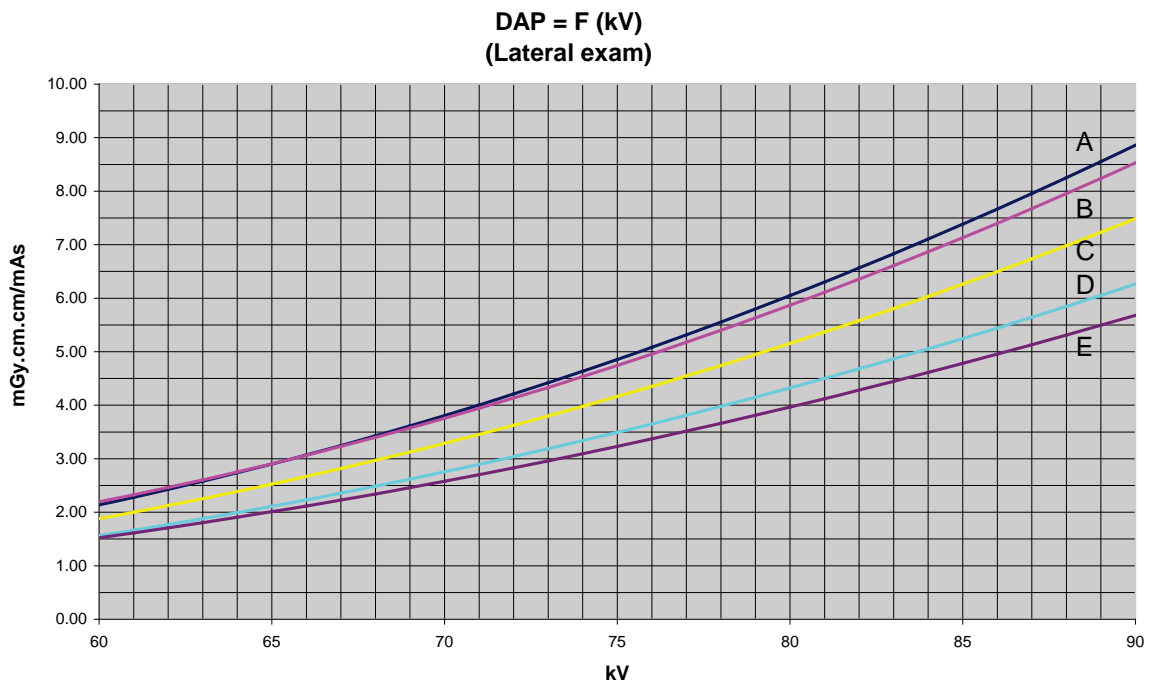
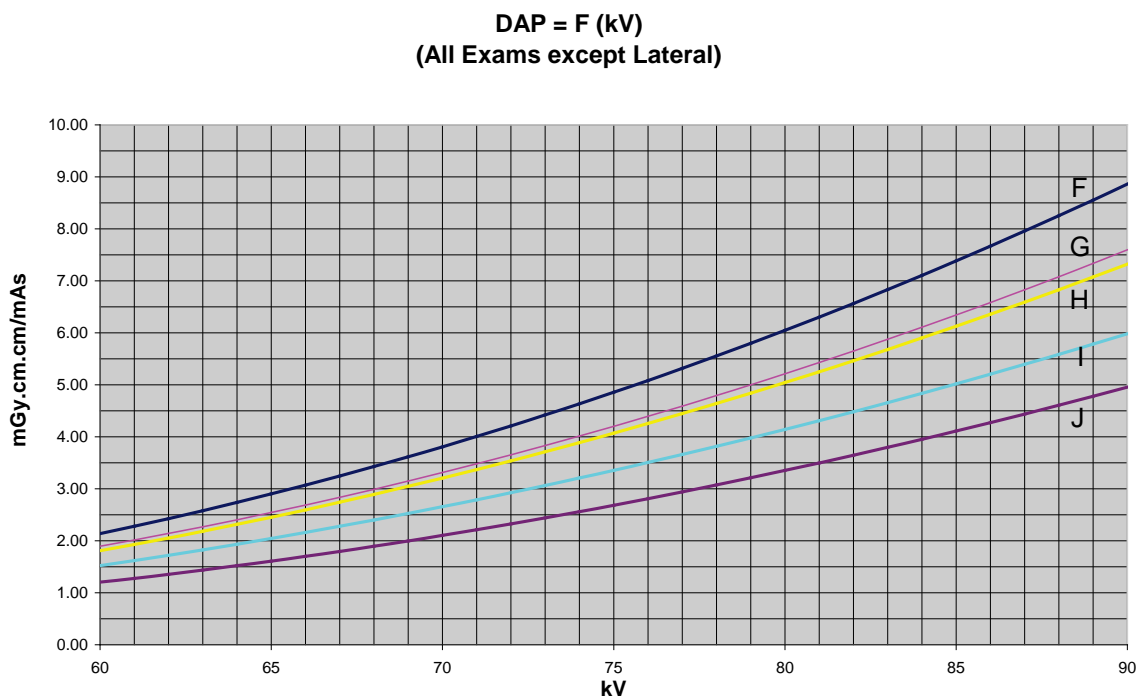

Figure 7 Cephalometric Mode (all exams except Lateral exam)



Example of a patient dose estimation in Adult Medium cephalometric mode.
(30x30, Lateral exam).

Radiological setting: 80 kV x 15 mA x 0.5 s

mAs = 15 mA x 0.5 s = 7.5 mAs

at 80 kV DAP = 6.05 mGy.cm²/mAs (see Curve A : Figure 6)

Patient dose estimation = 7.5 mAs x 6.05 mGy.cm²/mAs = 45.37 mGy.cm²

User Dose information

Stray radiation

Stray radiation measures are highly dependent on environmental conditions, such as the composition of walls and their locations, therefore in certain circumstances the values may be significantly different.

The points of measurement used are at 0.5 m, 1.0 m and 2.0 m respectively from the central rotation axis.

Figure 8 **Circular Points of Measurement**

Points of Measurement	
1	Circular Points of Measurement
2	Rotation Axis

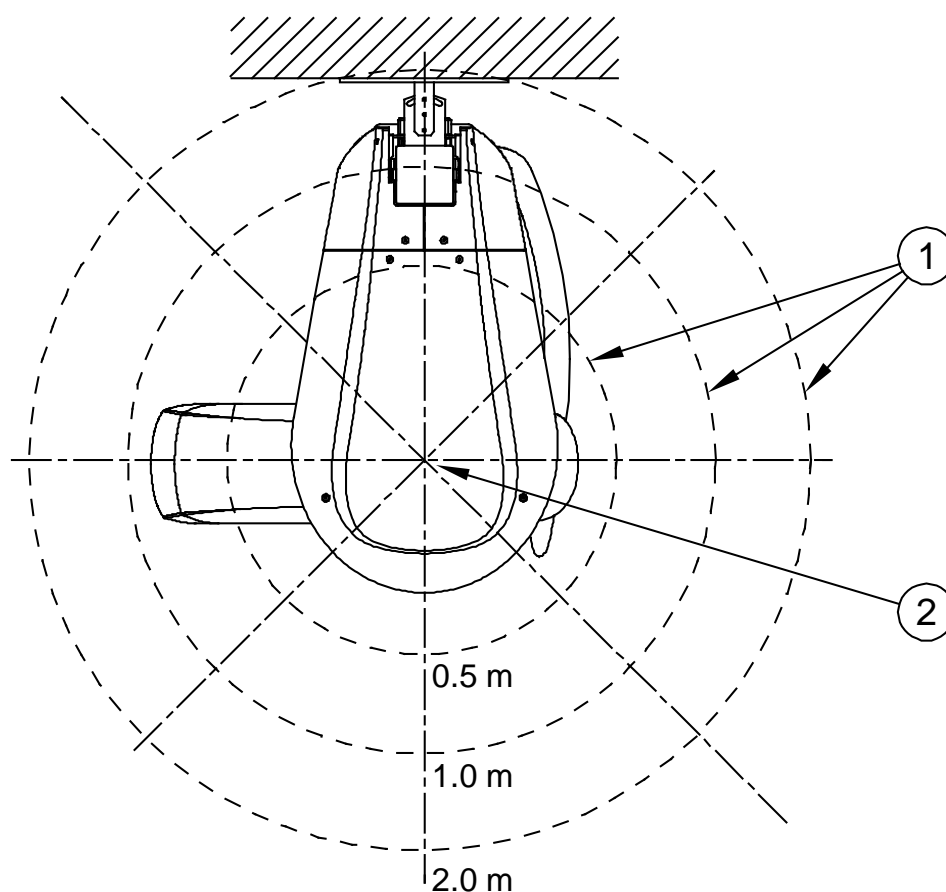

3D Mode for CS 9300 and CS 9300C

The size of the test volume is 17 cm x 13.5 cm (High quality mode) with a PMMA (transparent thermoplastic) phantom cylinder (Φ 16 cm x h 15 cm) to simulate a human head. Stray radiation measured at 85 kV x 12 mA x 11.3 s.

Stray radiation measured at the maximum use rate permitted by the X-ray generator, (this corresponds to a continuous average anodic power of 33 W), or 11 exams per hour.	
Distance between the rotation axis and measurement point (Circular Points of Measurement)	Stray radiation*
0.5 m	840 μ Gy/h
1.0 m	210 μ Gy/h
2.0 m	53 μ Gy/h

Stray radiation measured at the mean use rate in a typical practice, or 2 exams per hour.	
Distance between the rotation axis and measurement point (Circular Points of Measurement)	Stray radiation*
0.5 m	152 μ Gy/h
1.0 m	38 μ Gy/h
2.0 m	10 μ Gy/h

*This is the maximum value measured 30 cm below the horizontal cross sectional plane with a chin rest. Other values in the vertical axis are lower than these values.

3D Mode for CS 9300 Select and CS 9300C Select

The size of the test volume is 10 cm x 10 cm with a PMMA (transparent thermoplastic) phantom cylinder (Φ 16 cm x h 15 cm) to simulate a human head. Stray radiation measured at 85 kV x 12 mA x 6.2 s.

Stray radiation measured at the maximum use rate permitted by the X-ray generator, (this corresponds to a continuous average anodic power of 33 W), or 11 exams per hour.	
Distance between the rotation axis and measurement point (Circular Points of Measurement)	Stray radiation*
0.5 m	580 μ Gy/h
1.0 m	145 μ Gy/h
2.0 m	36 μ Gy/h

Stray radiation measured at the mean use rate in a typical practice, or 2 exams per hour.	
Distance between the rotation axis and measurement point (Circular Points of Measurement)	Stray radiation*
0.5 m	64 μ Gy/h
1.0 m	16 μ Gy/h
2.0 m	4 μ Gy/h

*This is the maximum value measured 30 cm below the horizontal cross sectional plane with a chin rest. Other values in the vertical axis are lower than these values.

3D Mode Teeth for CS 9300 Family

The size of the volume is 5 cm x 5 cm (Fast Acquisition mode) with a PMMA (transparent thermoplastic) phantom cylinder (Φ 16 cm x h 15 cm) to simulate a human head. Stray radiation measured at 85 kV x 12 mA x 12 s.

Stray radiation measured at the maximum use rate permitted by the X-ray generator, (this corresponds to a continuous average anodic power of 33 W), or 10 exams per hour.	
Distance between the rotation axis and measurement point (Circular Points of Measurement)	Stray radiation*
0.5 m	256 μ Gy/h
1.0 m	64 μ Gy/h
2.0 m	16 μ Gy/h

Stray radiation measured at the mean use rate in a typical practice, or 2 exams per hour.	
Distance between the rotation axis and measurement point (Circular Points of Measurement)	Stray radiation*
0.5 m	52 μ Gy/h
1.0 m	13 μ Gy/h
2.0 m	3 μ Gy/h

*This is the maximum value measured 30 cm below the horizontal cross sectional plane with a chin rest. Other values in the vertical axis are lower than these values.

Panoramic Mode for CS 9300 Family

Stray radiation measured at 85 kV x 16 mA x 12 s (Large Adult) with a PMMA (transparent thermoplastic) phantom cylinder (Φ 16 cm x h 15 cm) to simulate a human head.

Stray radiation measured at the maximum use rate permitted by the X-ray generator, (this corresponds to a continuous average anodic power of 33 W), or 8 exams per hour.	
Distance between the rotation axis and measurement point (Circular Points of Measurement)	Stray radiation*
0.5 m	60 μ Gy/h
1.0 m	15 μ Gy/h
2.0 m	4 μ Gy/h

Stray radiation at mean use rate in practice, or 2 exams per hour.	
Distance between the rotation axis and measurement point (Circular Points of Measurement)	Stray radiation*
0.5 m	16 μ Gy/h
1.0 m	4 μ Gy/h
2.0 m	1 μ Gy/h

*This is the maximum value measured 30 cm below the horizontal cross sectional plane with a chin rest. Other values in the vertical axis are lower than these values.

Imaging Performance Information

The value of the Modulation Transfer Function (MTF) at 10 % is superior to 1 lp/mm. The Signal-to-Noise Ratio (SNR) measured in an homogeneous 1mm-thick slice of PMMA* material is greater than 10.

The CS 9300 family does not provide Computed Tomography (CT) numbers, therefore, conventional analyses using CT numbers cannot be made.

*Polymethyl methacrylate (PMMA) is a transparent thermoplastic material.

Controlling the Image Quality

For optimum results, perform a control test of the image quality. To do this, see the *User Guide, Chapter 7, "Controlling the Image Quality"*.

CS 9300 Family Environmental Requirements

Ambient Operating Conditions	
Temperatures	10–35 °C
Relative humidity	30–80 %
Atmospheric pressure	700–1060 hpa
Altitude	Up to 3000 m

Storage Conditions	
Temperatures	-10–60 °C
Relative humidity	10–90 %
Atmospheric pressure	700–1060 hpa

Transport Conditions	
Temperatures	-10–60 °C
Relative humidity	10–90 %
Atmospheric pressure	700–1060 hpa

CS 9300 Family Electrical Specifications

Type of Electrical Power Supply	220-240 V ~ ($\pm 10\%$) 50/60 Hz, Single-Phase	100-130 V ~ ($\pm 10\%$) 50/60 Hz, Single-Phase
Acceptable fluctuation	$\pm 10\%$	$\pm 10\%$
Apparent resistance of the power supply circuit	0.5 Ω (max)	0.12 Ω (max)
Permanent absorbed current	1.0 A	1.0 A
Current absorbed during the X-ray emission	10 A	22 A
Maximum absorbed power	2.2 kVA	2.2 kVA
Protection for the power supply system	By shutter release at a maximum current of 16 A and a differential current of 30 mA	By shutter release at a maximum current of 20 A and a differential current of 30 mA
Nominal high voltage	90 kV	90 kV
Maximum corresponding tube current	10 mA	10 mA
Nominal tube current	15 mA	15 mA
Maximum corresponding high voltage	80 kV	68 kV
Tube current/voltage combination for maximum output power	80 kV, 15 mA	85 kV, 12 mA
Nominal output power for an exposure time of 0.1 s.	at 90 kV, 10 mA: 900 W	at 90 kV, 10 mA: 900 W

Selection of the Load Parameters:

kV (in increments of 1 kV)	From 60 to 90 kV
mA (in increments of 25 %)	From 2 to 15 mA

Accuracy of the Load Parameters	
High voltage	kV $\pm 10\%$
Current in the tube	mA $\pm 20\%$
Exposure time seconds	s $\pm(10\% + 1\text{ ms})$ or $\pm(5\% + 50\text{ ms})$
Measurement Conditions	
kV	Indirect on the peak kilovolt meter
mA	Direct measurement in the circuit using an oscilloscope
Exposure time	Measurement at 75 % of the kV values with peak kilovolt meter
Utilization Rate in Continuous Mode (for example: one exposure - 85 kV, 5 mA - 13.9 second, every 3 minutes)	Utilization Rate in Intermittent Mode (for example: one exposure - 80 kV, 15 mA - 13.9 second, every 3 minutes)
33 W	93 W

X-ray Tube Assembly Technical Specifications

Table 8 Filtration of the Material in the X-ray Field

Standard	Compliance
IEC 60601-1-3	Compliant
Nominal value of the inherent filtration at 70 kV	2.5 mm (0.10") eq. Al
Nominal value of the supplementary filtration at 70 kV	0.1 mm (0.004") Cu
Nominal value of the total filtration at 70 kV	2.5 mm (0.10") eq. Al + 0.1 mm Cu
Filtration value for the enclosure of the X-ray tube (at 100 kV)	0.2 mm (0.008")
Filtration value for the enclosure of the image receiver unit (at 100 kV)	0.2 mm (0.008")
Filtration value for the sensor case	0.3 mm (0.012") eq. Al

The X-ray generator comprises the following:

- A transformer and an X-ray tube and their associated electronic components immersed in oil.
- An aluminum filter, which enhances the quality of the beam and reduces the dose received by the patient.
- A lead collimator, which limits the size of the beam at the image receiver unit.
- A thermal cutout, which trips at an operating temperature between 63 to 70 °C (± 5 °C).
- Copper filter.

Figure 9 Location of the Reference Axis for Panoramic Imaging

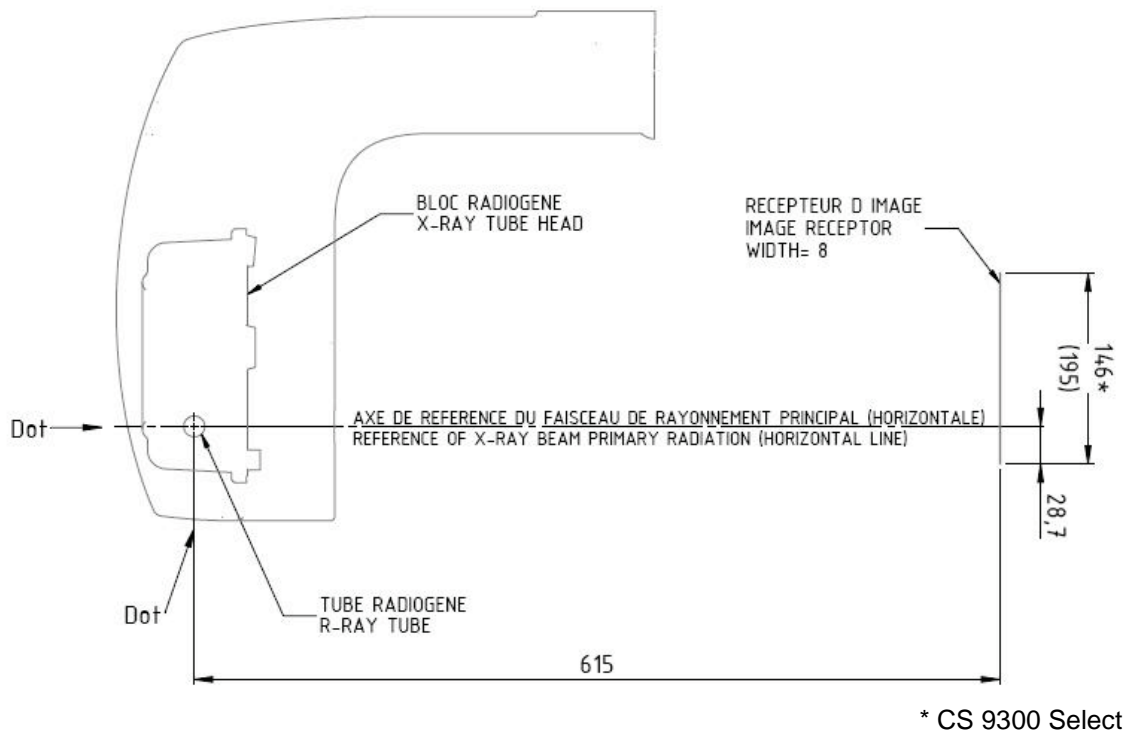

Figure 10 Location of the Reference Axis for 3D Imaging

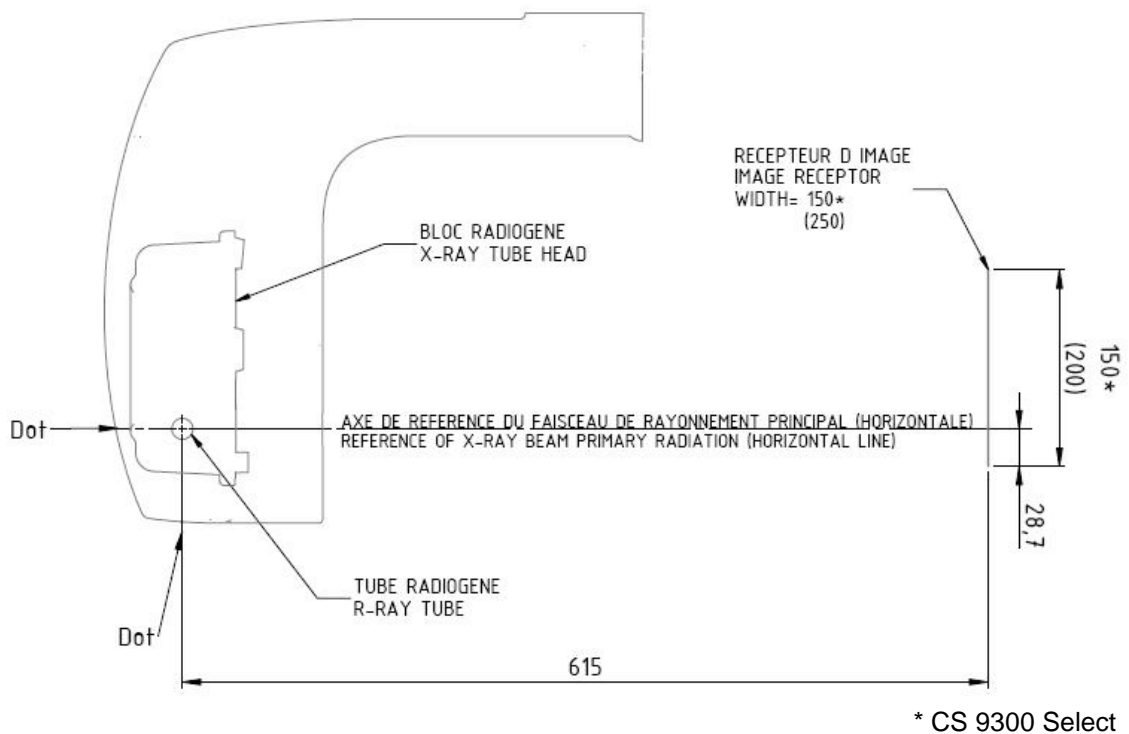

Figure 11 **Location of the Reference Axis for Cephalometric Imaging**

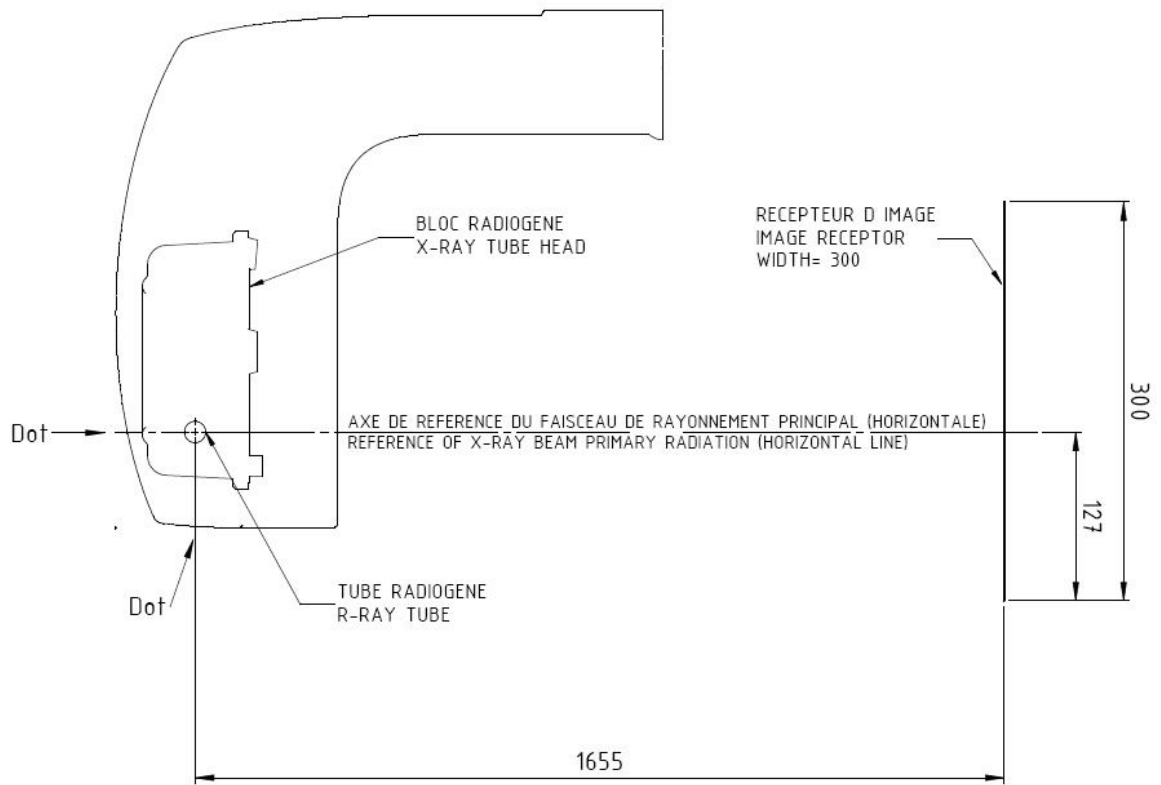

Table 9 Technical Specifications of the X-ray tube Assembly

Standard	Compliance
Manufacturer	Trophy
Degree of protection against electric shock	Class I
Degree of patient protection from the parts applied to the leakage current	Type B
Operation mode	Continuous operation with intermittent loading
Maximum accumulated heat	110 kJ
Maximum continuous heat dissipation	33 W
Tolerances on the position of the focal spot	± 2.5 mm
Continuous Anode Input Power that corresponds to the maximum specified energy input to the Anode (110kJ)	33W at 90kV
Radiation leakage after one hour's operation (maximum utilization rate of 33W)	< 1 mGy
Weight	8.2 kg
Dimensions	235 x 245 x 120 mm



IMPORTANT

To increase the operating life of the X-ray tube, at the first loading or if the unit has not been used for a month, you must follow the following procedures before use:

1. In the **Panoramic Acquisition** interface, select the **Parameter pane**.
2. Select the following series of parameter settings:
 - 70 kV - 6.3 mA
 - 80 kV - 10 mA
 - 85 kV - 10 mA
3. Leave the X-ray room and close the door. For each parameter setting, from the X-ray remote control, press and hold the button to launch the X-ray

The unit is now ready to be used for acquisition.

Figure 12 Heating and Cooling Curves of the X-ray Tube Assembly

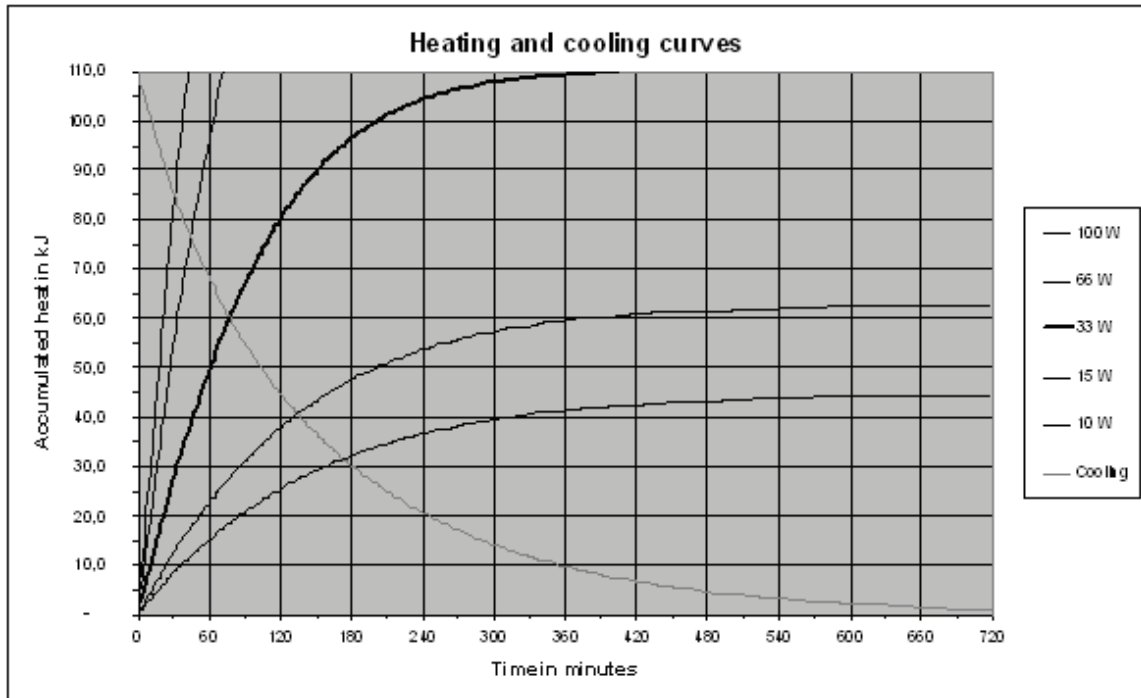

Table 10 Beam Limited Device

Manufacturer	Type
Ralco	Model R11 Rigidly mounted unit with fixed window dimensions, not removable, and integrated X-ray generator

Table 11 **Beam Limitations of the X-ray Tube Assembly**

Examination Type	X-ray Beam Size
Panoramic Mode for CS 9300 and CS 9300C Maximum symmetrical field of radiation at a distance of 615 mm from the focal point	5 (-0.5/+2) x 146 (±2) mm 5 (-0.5/+2) x 116 (±2) mm At the detector reference plane
Panoramic Mode for CS 9300 Select and CS 9300C Select Maximum symmetrical field of radiation at a distance of 615 mm from the focal point	5 (-0.5/+2) x 143 (±2) mm 5 (-0.5/+2) x 116 (±2) mm At the detector reference plane
3D Mode for CS 9300 and CS 9300C Maximum symmetrical field of radiation at a distance of 615 mm from the focal point	<ul style="list-style-type: none"> • 239 (±2) x 190 (±2) mm • 239 (±2) x 107 (±2) mm • 141 (±2) x 157 (±2) mm • 141 (±2) x 83.3 (±2) mm • 112 (±2) x 122 (±2) mm • 72 (±2) x 78 (±2) mm At the detector reference plane
3D Mode for CS 9300 Select and CS 9300C Select Maximum symmetrical field of radiation at a distance of 615 mm from the focal point	<ul style="list-style-type: none"> • 145 (±2) x 145 (±2) mm • 145 (±2) x 87 (±2) mm • 115 (±2) x 125 (±2) mm • 74 (±2) x 79 (±2) mm At the detector reference plane
Cephalometric Mode Maximum symmetrical field of radiation at a distance of 1655 mm from the focal point.	<ul style="list-style-type: none"> • 205 (±15) x 205 (±15) mm • 205 (±15) x 274 (±15) mm • 274 (±15) x 274 (±15) mm • 274 (±15) x 300 (±15) mm • 300 (±15) x 300 (±15) mm At the detector reference plane

Table 12 **Characteristics of the X-ray Tube**

Manufacturer's name	CEI	Toshiba or Canon
Type	OPX 110	D-067
Nominal high voltage	110 kV	100 kV
Nominal anode input power	2000 W (at 0.1 s)	1270 W (at 1.0 s)
Anode heat storage capacity	30 kJ	35 kJ
Nominal focal spot size (EN 60336)	0.7 mm	0.6 mm
Anode materials	Tungsten	Tungsten
Target angle	12°	12°
Inherent filtration	0.5 mm (0.20") eq. Al	0.8 mm (0.032")eq. Al

Figure 13 X-ray tube drawing: OPX 110

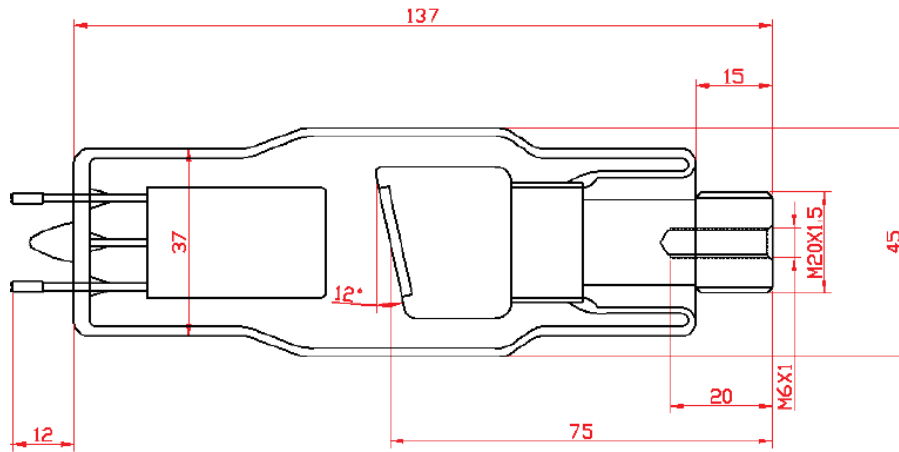

Figure 14 X-ray tube drawing: D-067

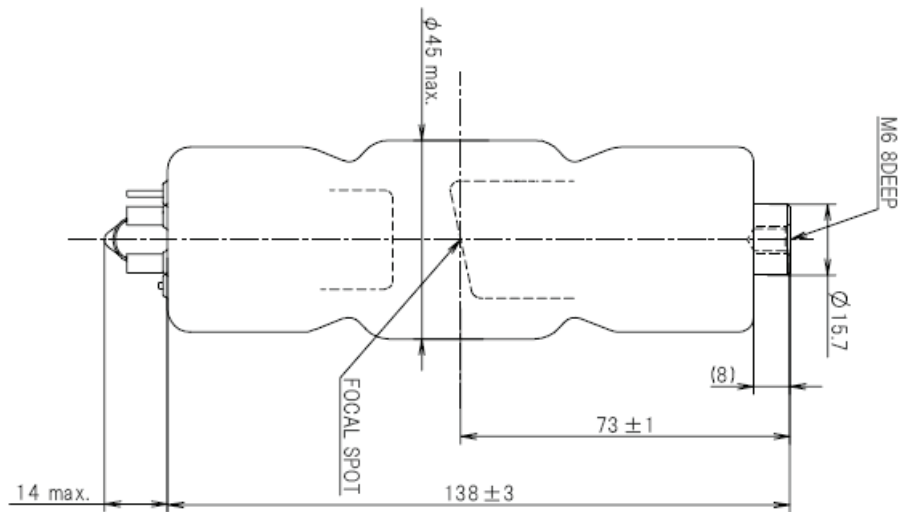

Figure 15 Heating and Cooling Curves of the X-ray Tube: OPX 110

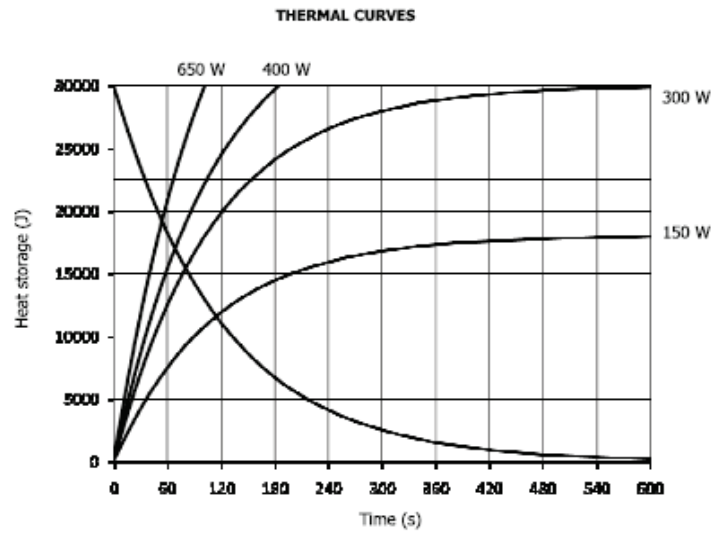

Figure 16 Heating and Cooling Curves of the X-ray Tube: D-067

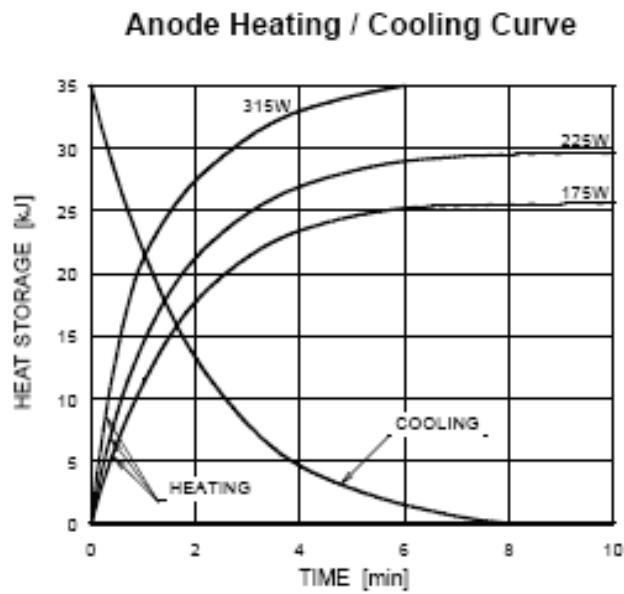

Figure 17 Single Load Chart of the X-ray Tube: OPX 110

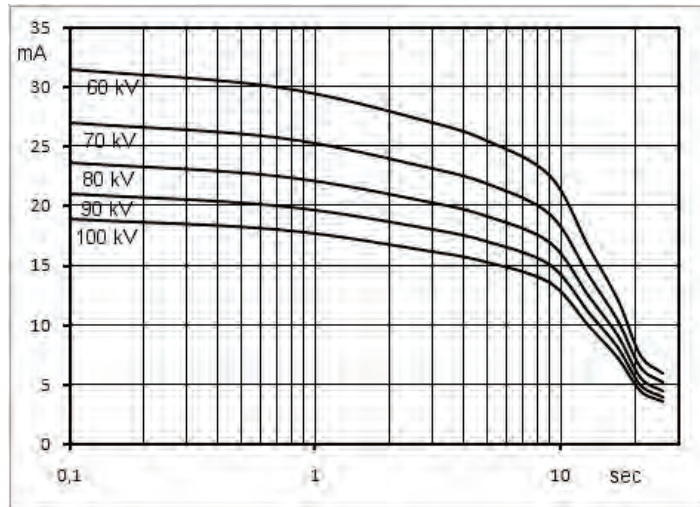

Figure 18 Single Load Chart of the X-ray Tube: D-067

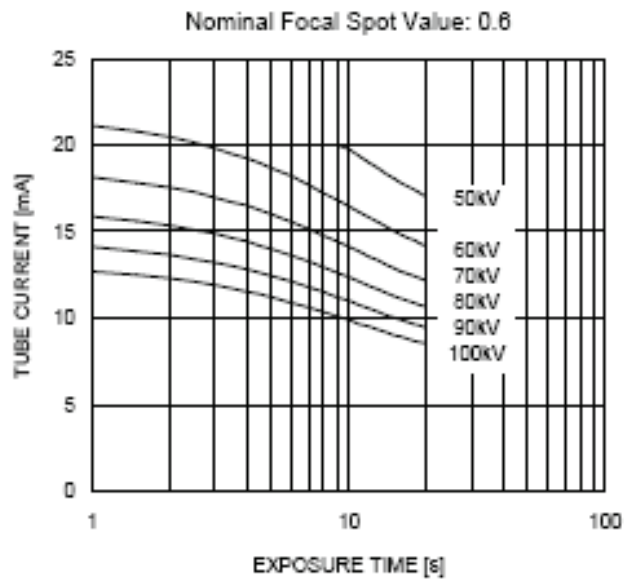

Figure 19

Filament Emissions of the X-ray Tube: OPX 110

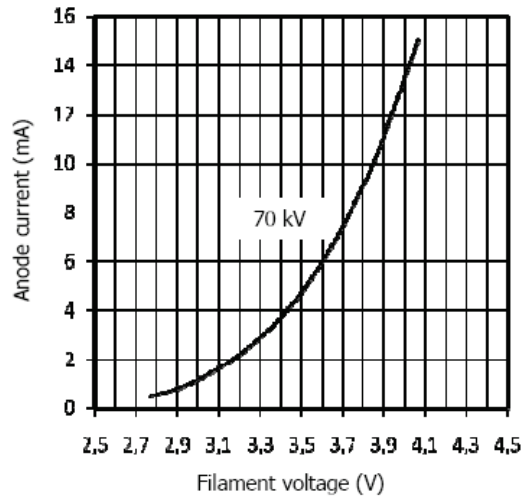
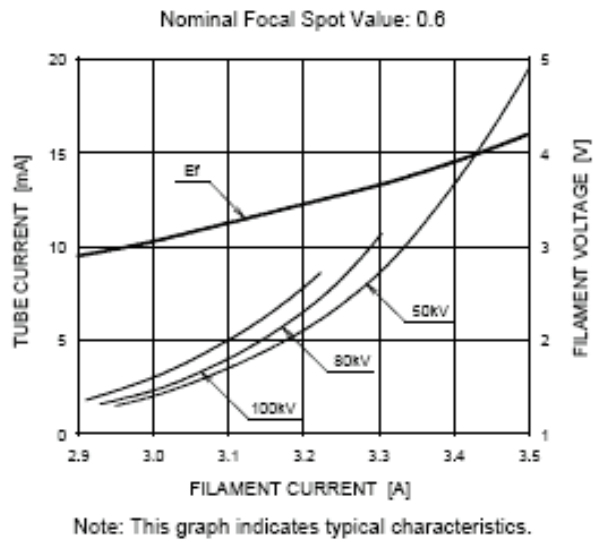

Figure 20

Filament Emissions of the X-ray Tube: D-067



4 Contact Information

Manufacturer's Address



Carestream Dental LLC
3625 Cumberland Boulevard, Suite 700,
Atlanta, GA USA 30339

Authorized Representatives

Authorized Representative in the European Community



Trophy
4, Rue F. Pelloutier, Croissy-Beaubourg
77435 Marne la Vallée Cedex 2, France

Authorized Representative in Brazil

CARESTREAM DENTAL BRASIL EIRELI
Rua Romualdo Davoli, 65
1º Andar, Sala 01 - São José dos Campos
São Paulo - Brazil
Cep (Zip Code): 12238-577